

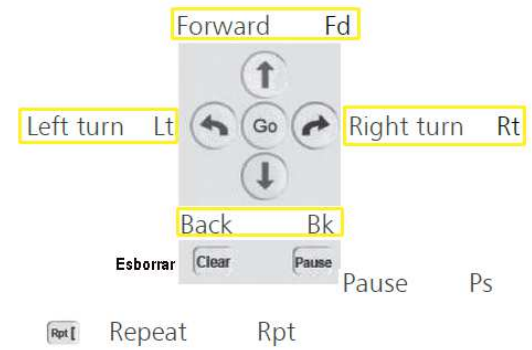

↔  
Pro-Bot 25cm



# Pro-Bot



ESCOLA REIXAC

Per fer repeticions d'instruccions:



ESCOLA REIXAC



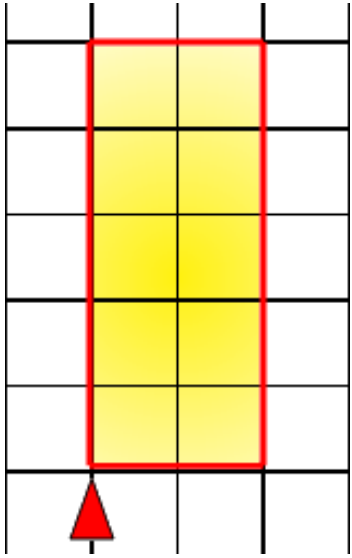

1

Rpt 2 [  
 Fd 20  
 Rt  
 Fd 10  
 Rt  
 ]



ESCOLA REIXAC

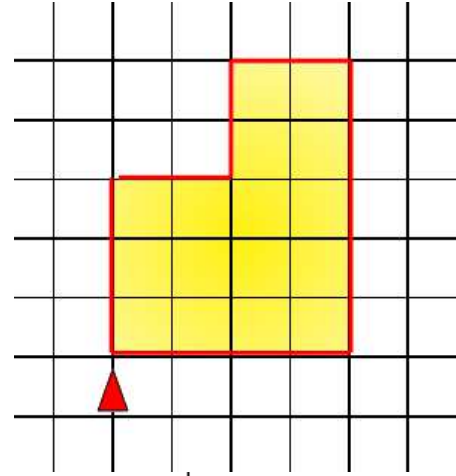

2

Fd 15  
 Rt  
 Fd 10  
 Lt  
 Fd 10  
 Rt  
 Fd 10  
 Rt  
 Fd 25  
 Rt  
 Fd 20



ESCOLA REIXAC

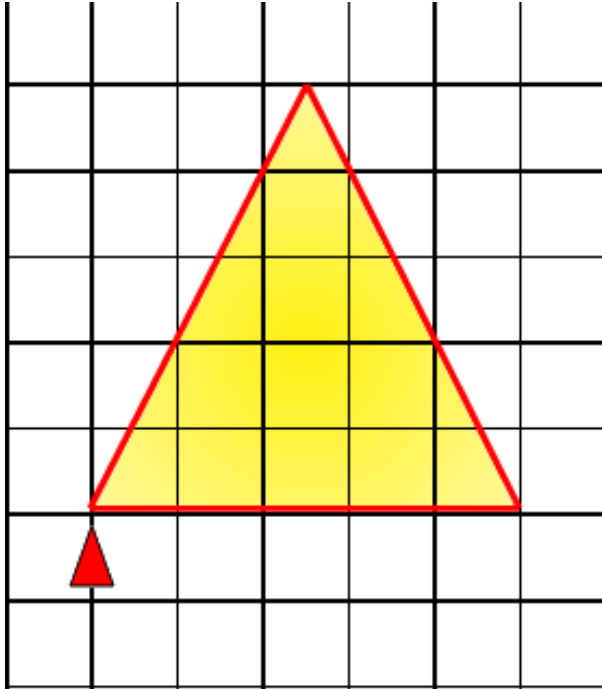

3

Rpt 3 [  
Fd 20  
Rt 120  
]



ESCOLA REIXAC

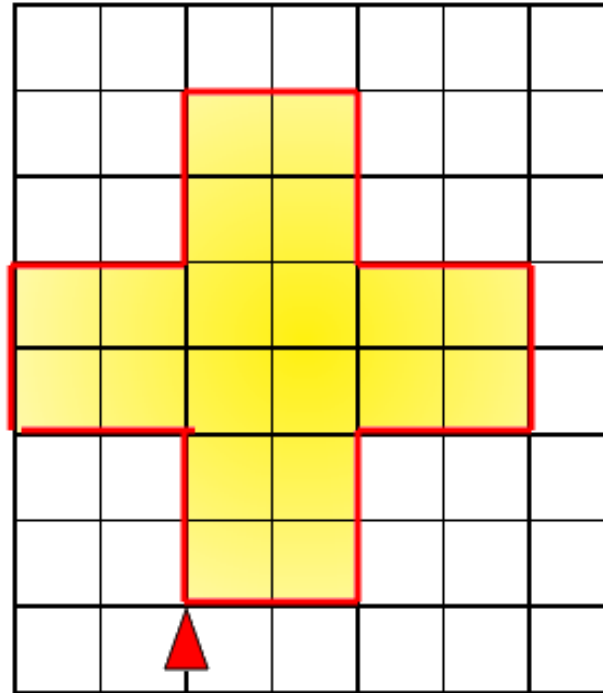

4

Rpt 4 [  
Fd 20  
Rt  
Fd 20  
Rt  
Fd 20  
Lt  
]



ESCOLA REIXAC

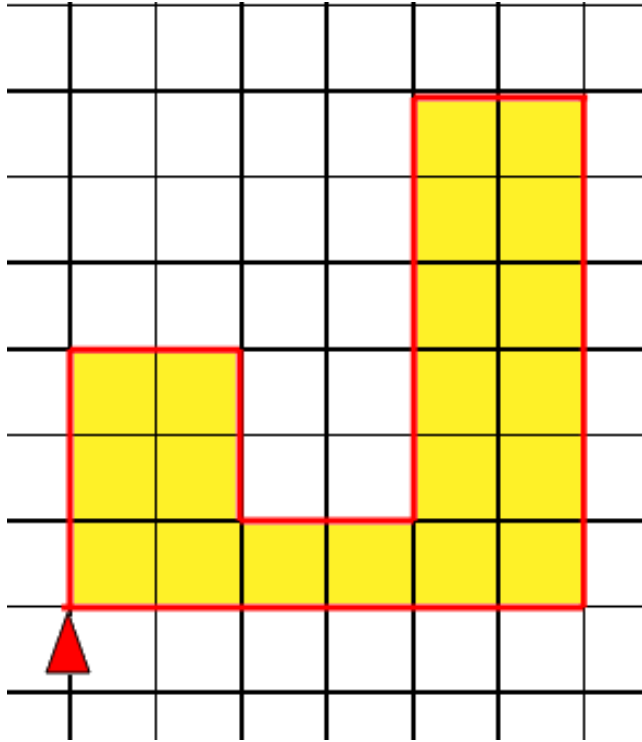

5



ESCOLA REIXAC

Fd 30  
Rt  
Fd 20  
Rt  
Fd 20  
Lt  
Fd 20  
Lt  
Fd 50  
Rt  
Fd 20  
Rt  
Fd 60  
Rt  
Fd 60  
Rt

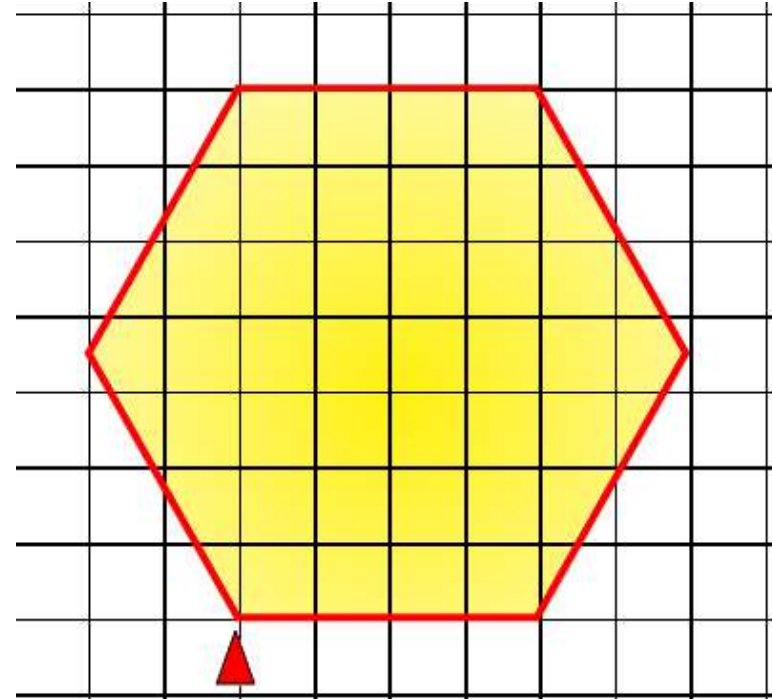

6



ESCOLA REIXAC

Rpt 6 [  
Fd 20  
Rt 60  
]

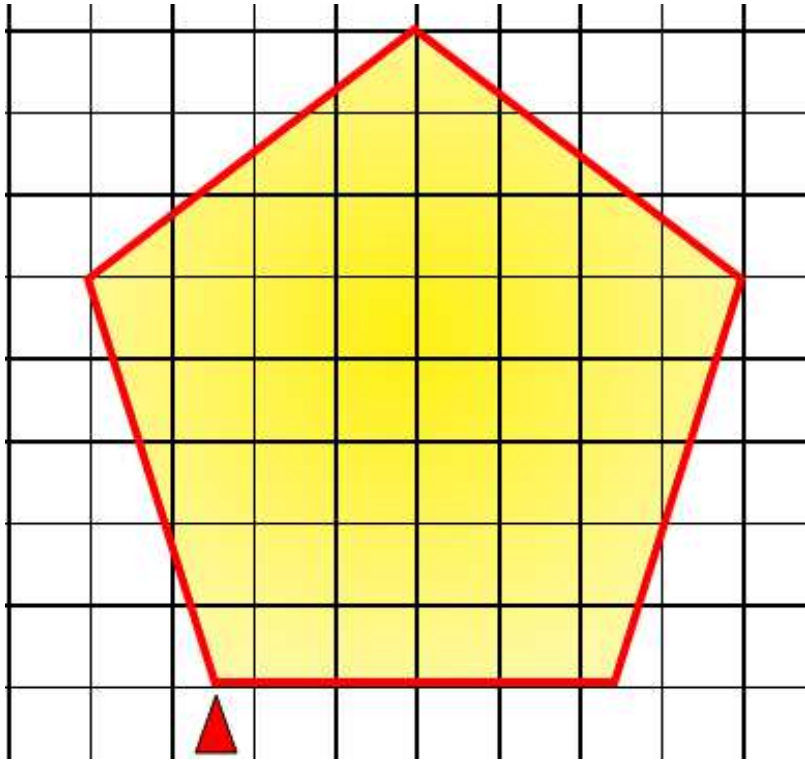

**7**

Rpt 5 [  
Fd 20  
Rt 72  
]



ESCOLA REIXAC

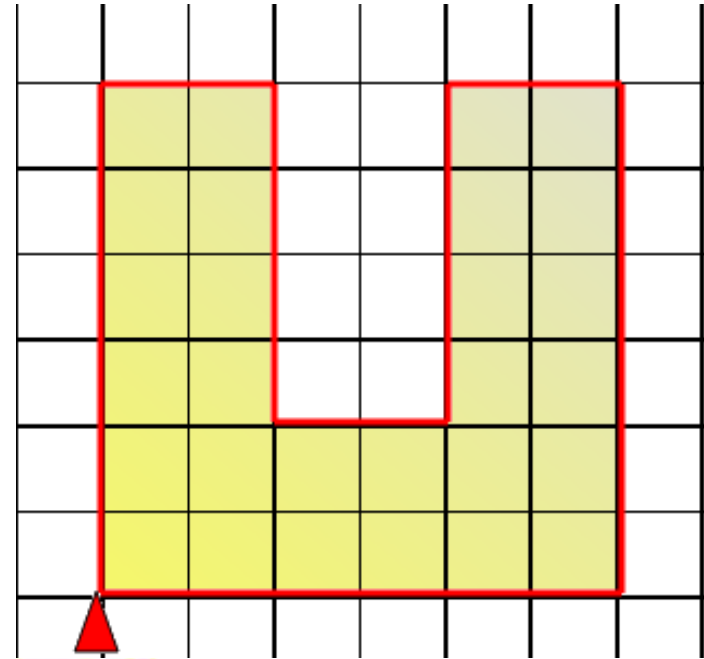

**8**

Fd 60  
Rt  
Fd 20  
Rt  
Fd 40  
Lt  
Fd 20  
Lt  
Fd 40  
Rt  
Fd 20  
Rt  
Fd 60  
Rt  
Fd 60  
Rt



ESCOLA REIXAC

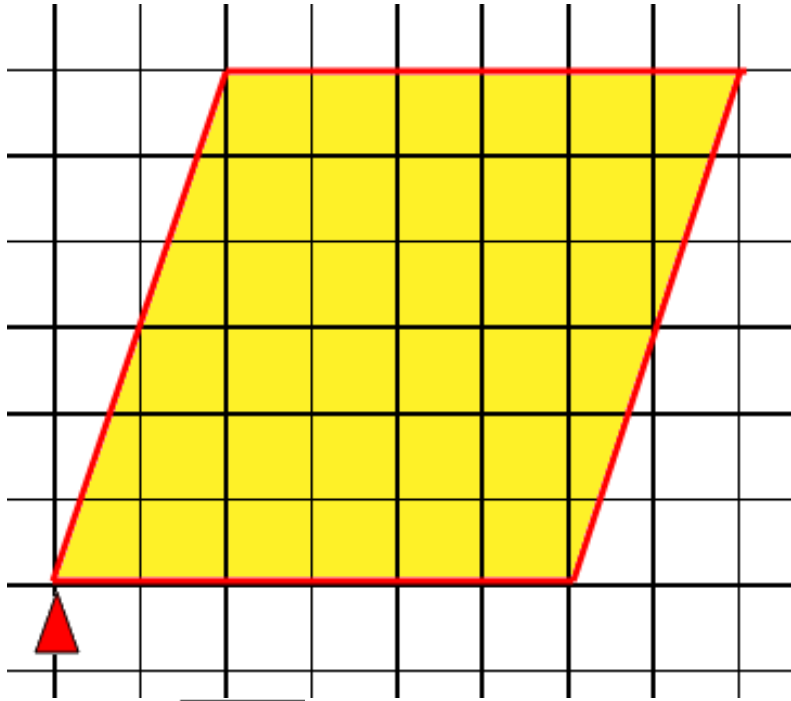

9

Rpt 2 [  
 Fd 40  
 Rt 132  
 Fd 60  
 Rt 48  
 ]



ESCOLA REIXAC

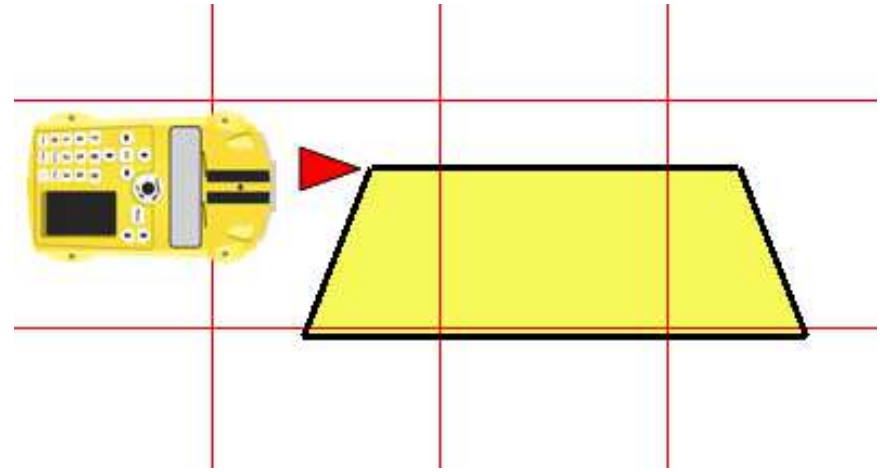

10

Fd 40  
 Rt 68  
 Fd 20  
 Rt 112  
 Fd 55  
 Rt 112  
 Fd 20  
 Rt 68



ESCOLA REIXAC

CREA UNA LLETRA DE L'ABECEDARI

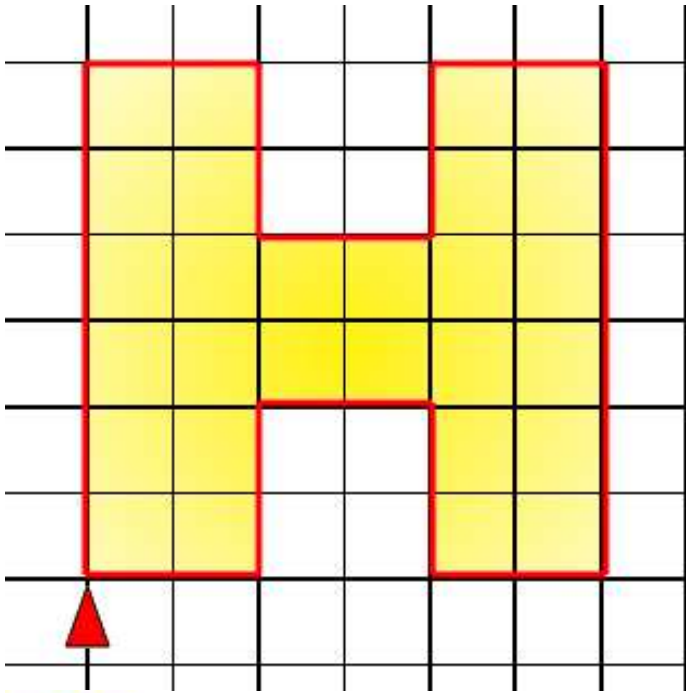

Fd 60  
Rt  
Fd 20  
Rt  
Fd 20  
Lt  
Fd 20  
Lt  
Fd 20  
Rt  
Fd 20  
Rt  
Fd 60  
Rt  
Fd 20  
Rt  
Fd 20  
Lt  
Fd 20  
Rt  
Fd 20  
Rt

12

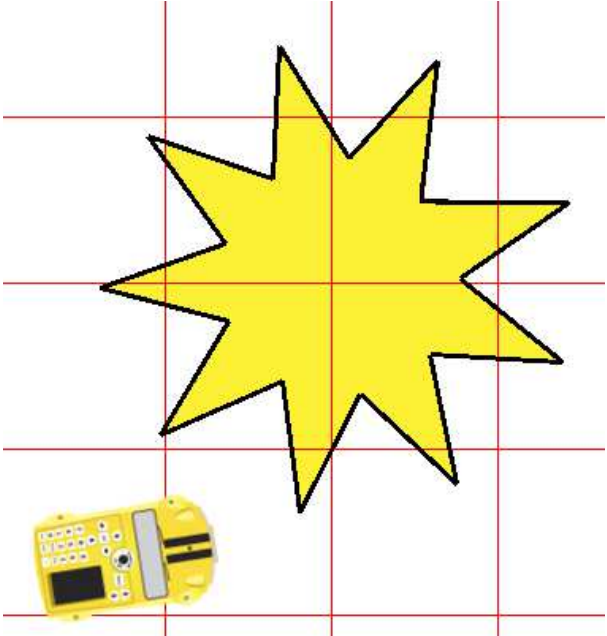

11

Rpt 9 [  
Fd 20  
Rt 145  
Fd 20  
Lt 106  
]



ESCOLA REIXAC



ESCOLA REIXAC

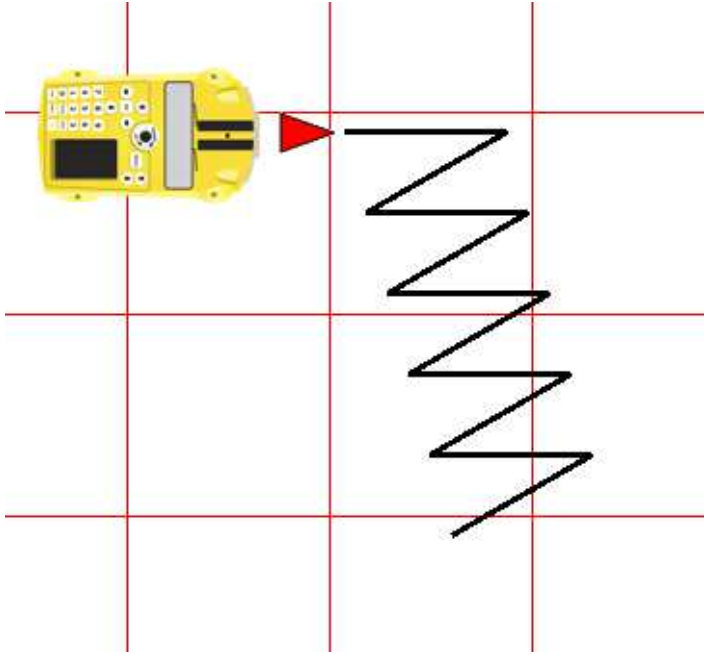

13

Rpt 5 [  
Fd 20  
Rt 150  
Fd 20  
Lt 150  
]



ESCOLA REIXAC



ESCOLA REIXAC



# CREA AQUESTES LLETRES

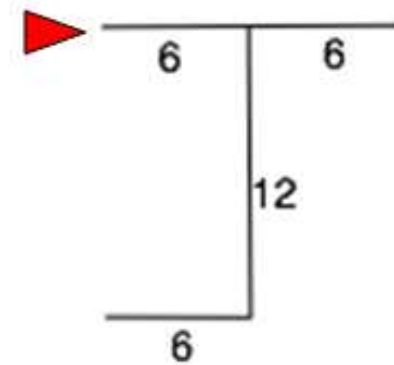
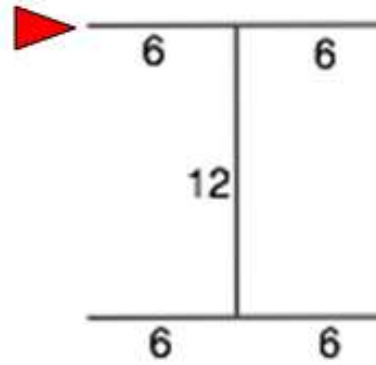
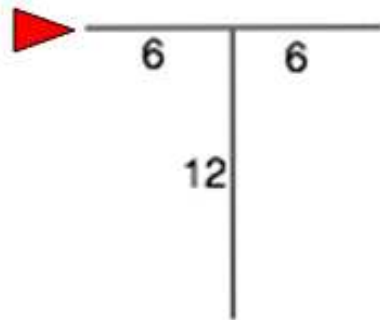

14

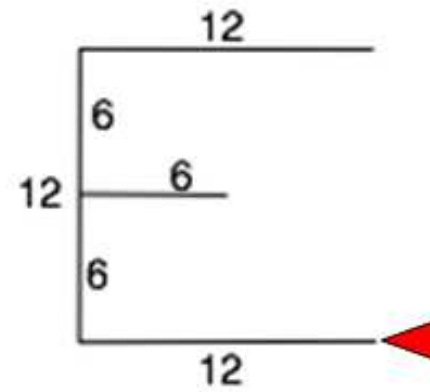
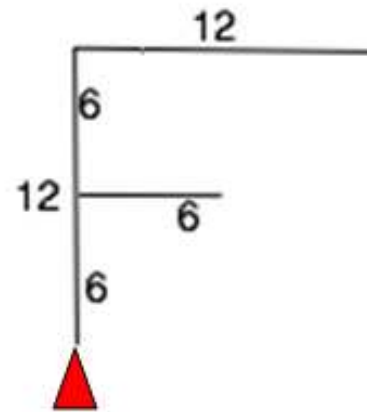

ESCOLA REIXAC



ESCOLA REIXAC

# SOLUCIONS FITXA

14

<u>Letter T:</u> Fd 12 Bk 6 Rt Fd 12	<u>Letter I:</u> Fd 12 Bk 6 Rt Fd 12 Rt Fd 6 Bk 12	<u>Letter J:</u> Fd 12 Bk 6 Rt Fd 12 Rt Fd 6
<u>Letter F:</u> Fd 6 Rt Fd 6 Bk 6 Lt Fd 6 Rt Fd 12	<u>Letter E:</u> Fd 12 Rt Fd 6 Rt Fd 6 Bk 6 Lt Fd 6 Rt Fd 12	



ESCOLA REIXAC



ESCOLA REIXAC

# SOLUCIONS FITXA

# 15

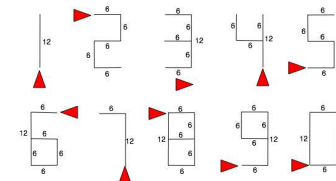

<p><b>Number 1:</b> Fd 12</p>	<p><b>Number 2:</b> Fd 6 Rt Fd 6 Rt Fd 6 Lt Fd 6 Lt Fd 6</p> <p><b>Rpt 5 (Fd 6 Rt)</b></p>	<p><b>Number 3:</b> Fd 6 Lt Fd 6 Rt Bk 6 Fd 6 Lt Fd 6 Lt Fd 6</p>	<p><b>Number 4:</b> Fd 12 Bk 6 Lt Fd 6 Rt Fd 6</p>	<p><b>Number 5:</b> Fd 6 Lt Fd 6 Lt Fd 6 Rt Fd 6 Rt Fd 6</p>
<p><b>Number 6:</b> Fd 6 Lt Fd 12 Lt Fd 6 Lt Fd 6 Lt Fd 6</p>	<p><b>Number 7:</b> Fd 12 Lt Fd 6</p>	<p><b>Number 8:</b> Fd 6 Lt Fd 6 Rt Bk 6 Fd 6 Lt Fd 6 Lt Fd 6 Lt Fd 6 Lt Fd 12</p>	<p><b>Number 9:</b> Fd 6 Lt Fd 12 Lt Fd 6 Lt Fd 6 Lt Fd 6</p>	<p><b>Number 0:</b> Fd 6 Lt Fd 12 Lt Fd 6 Lt Fd 12</p>



ESCOLA REIXAC



ESCOLA REIXAC

SOLUCIONS POLÍGONS

QUADRAT

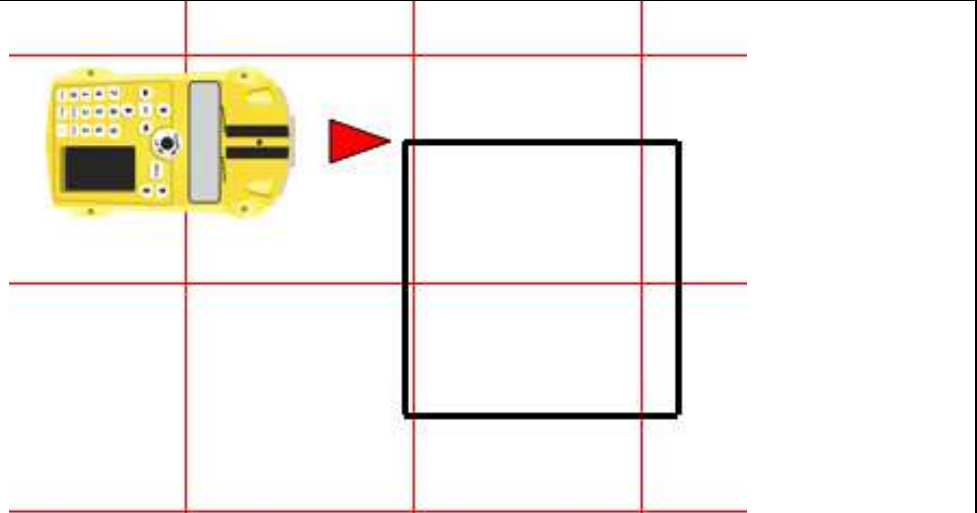

TRIANGLE

Rpt [ 3 ] [ ↑ ] [ 5 ] [ ↻ ] [ 1 ] [ 2 ] [ 0 ] [ 1 ]

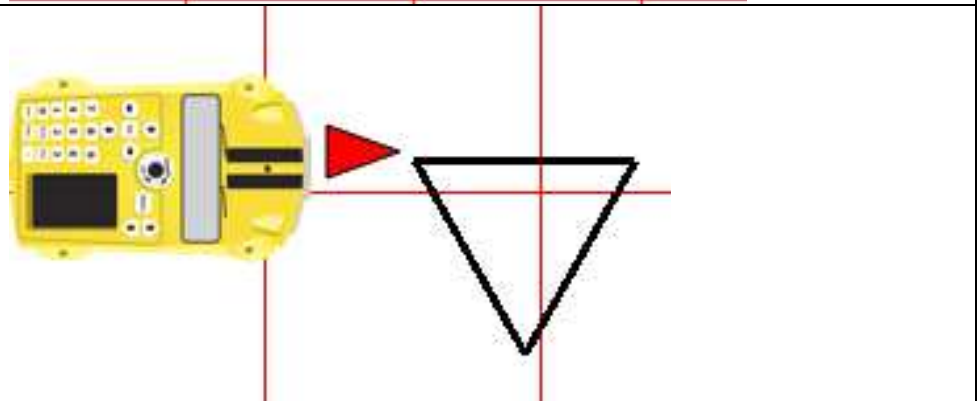

ESCOLA REIXAC



ESCOLA REIXAC

# PENTÀGON

Rpt [ 5 ] [ ↑ ] [ 5 ] [ ↻ ] [ 7 ] [ 2 ] [ 1 ]

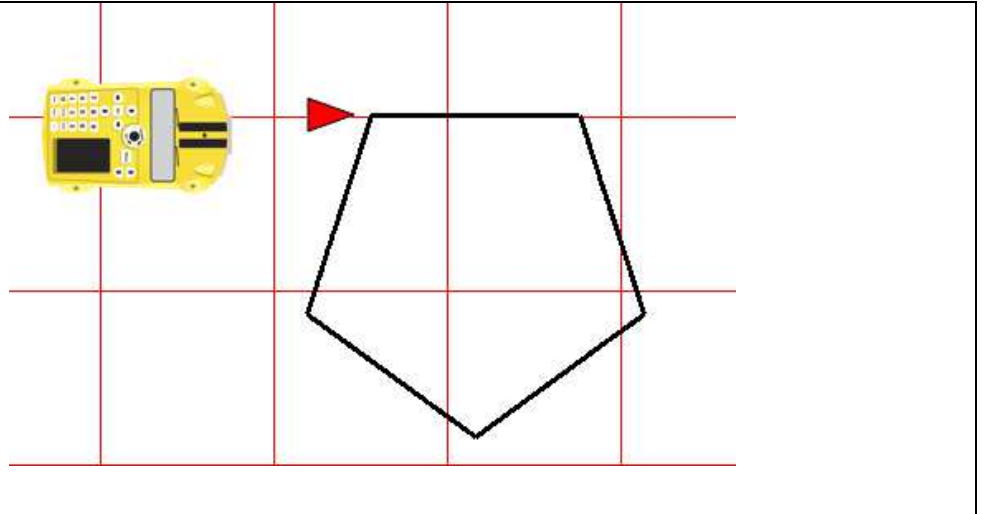

# HEXÀGON

Rpt [ 6 ] [ ↑ ] [ 5 ] [ ↻ ] [ 6 ] [ 0 ] [ 1 ]

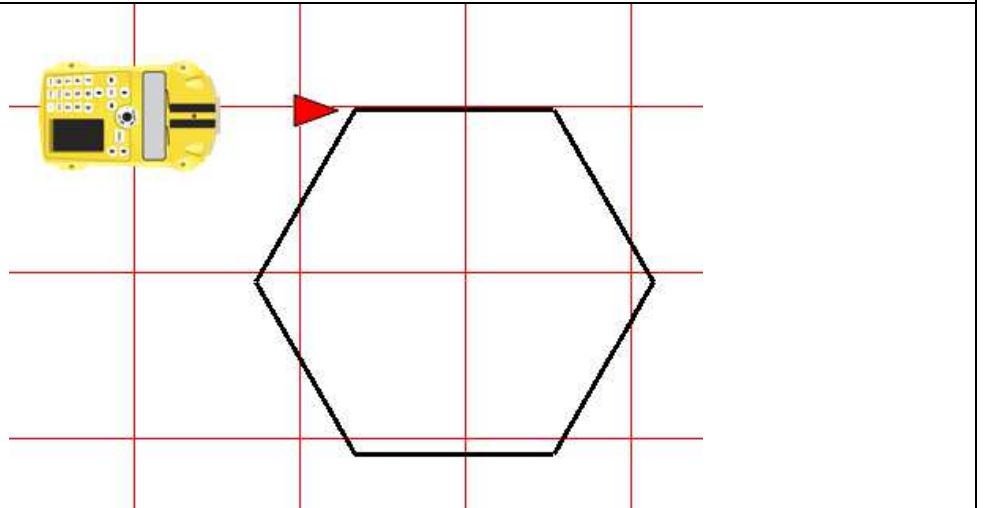

ESCOLA REIXAC



ESCOLA REIXAC

# OCTÀGON

Rpt [ 8 ] ↑ 5 ↻ 4 5 ]

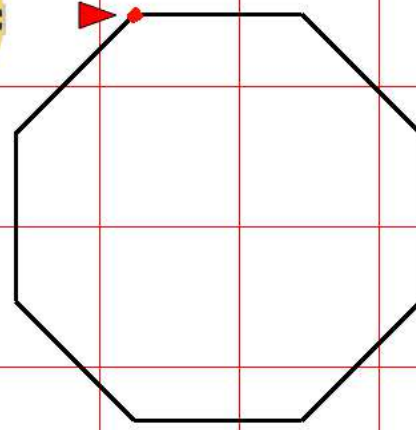
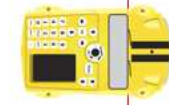

# NONÀGON

Rpt 9 [ Fd 20 Rt 40 ]

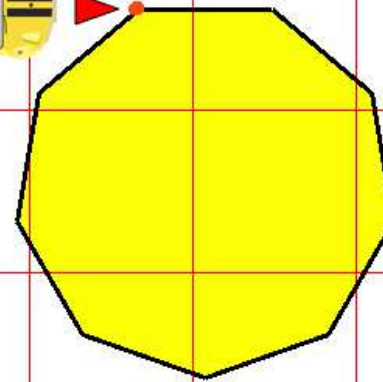
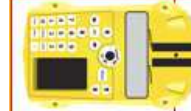

ESCOLA REIXAC



ESCOLA REIXAC

# DECÀGON

Rpt 10 [  
Fd 20  
Rt 36  
]

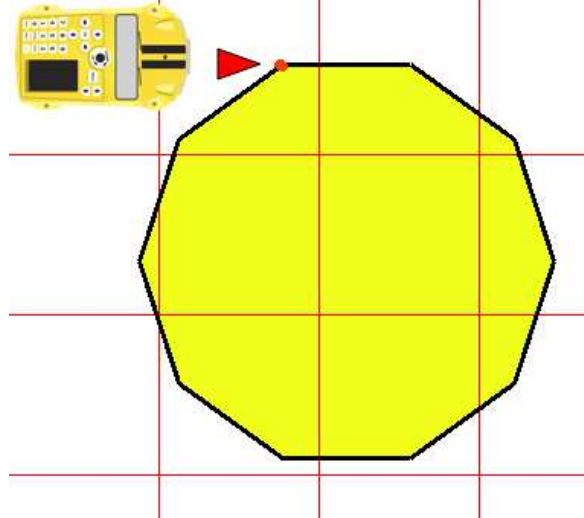

# DODECÀGON

Rpt 12 [  
Fd 20  
Rt 30  
]

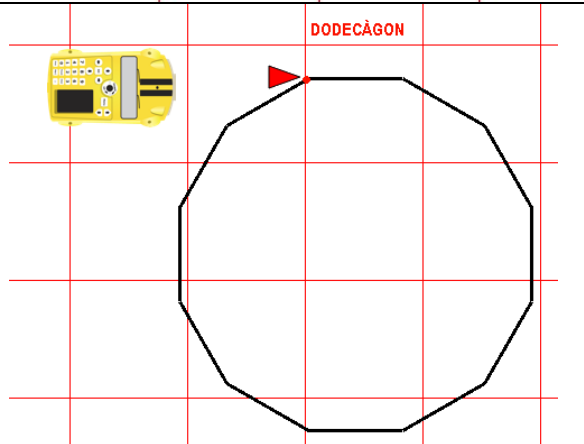

ESCOLA REIXAC



ESCOLA REIXAC

# CERCLE (aproximat)

Rpt I 2 0 ↑ 1 ↻ 1 8 1

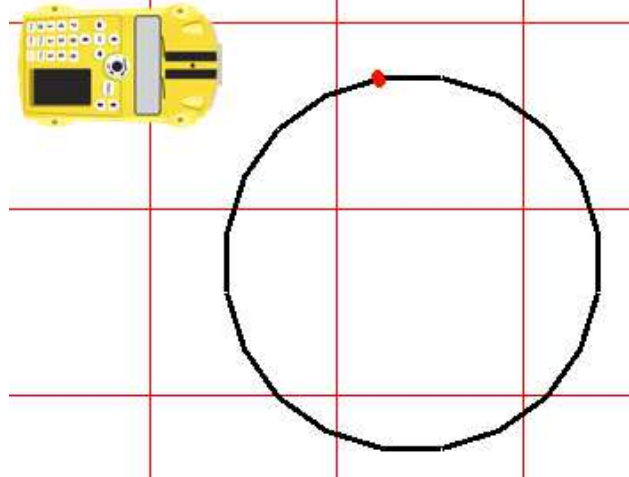

ESCOLA REIXAC



ESCOLA REIXAC